



USER MANUAL (ET Series)



FCC STATEMENT

1. This device complies with Part 15 of the FCC Rules. Operation is subject to the following two conditions:

- (1) This device may not cause harmful interference.
- (2) This device must accept any interference received, including interference that may cause undesired operation.

2. Changes or modifications not expressly approved by the party responsible for compliance could void the user's authority to operate the equipment.

NOTE: This equipment has been tested and found to comply with the limits for a Class B digital device, pursuant to Part 15 of the FCC Rules. These limits are designed to provide reasonable protection against harmful interference in a residential installation.

This equipment generates uses and can radiate radio frequency energy and, if not installed and used in accordance with the instructions, may cause harmful interference to radio communications. However, there is no guarantee that interference will not occur in a particular installation. If this equipment does cause harmful interference to radio or television reception, which can be determined by turning the equipment off and on, the user is encouraged to try to correct the interference by one or more of the following measures:

- Reorient or relocate the receiving antenna.
- Increase the separation between the equipment and receiver.
- Connect the equipment into an outlet on a circuit different from that to which the receiver is connected.
- Consult the dealer or an experienced radio/TV technician for help.

FCC Radiation Exposure Statement

This equipment complies with FCC radiation exposure limits set forth for an uncontrolled environment. This equipment should be installed and operated with minimum distance 20cm between the radiator & your body.

 The symbol indicates DC voltage.



RECYCLING: This product bears the selective sorting symbol for Waste electrical and electronic equipment (WEEE). This means that this product must be handled pursuant to European directive 2012/19/EU in order to be recycled or dismantled to minimize its impact on the environment.

Directory

(English)

Chapter I Introduction

1.1 Product Summary	2
1.2 Product Dimensions	2
1.3 Product Appearance	3
1.4 Product Specifications	5
1.5 Packaging and Accessories	5

Chapter II Operation Guidelines

2.1 Scanning Preparation	6
2.2 Work Mode	8
2.2.1 Computer Mode (USB-PC)	8
2.2.2 Presenter mode (HDMI;optional)	8

Chapter III Frequently Asked Questions and Troubleshooting

3.1 PC Mode(USB) Problems	9
3.2 Presenter mode (HDMI;optional)	10

Chapter IV Terms of Service

4.1 After Sale Service and Guarantee	11
4.2 Contact Information	12

Chapter I Introduction

1.1 Product Summary

The CZUR scanner is a new type of intelligent scanner whose foremost features are its extremely high scanning speed, its ability to recognize and correct for curved, incorrectly positioned, or soiled pages, and its ability to quickly and easily convert scanned pages to more useful formats (PDF, searchable PDF, TIFF, or text documents.)

The scanner can, using built-in algorithms, automatically handle pages otherwise difficult or very time-consuming to scan. For example, it can automatically flatten the curved pages of open books (using laser lines), erase fingerprints, automatically split double pages into two, and correct pages incorrectly positioned. This allows large books to be scanned and archived very quickly.

It's a completely new approach to scanning and can save hours of time scanning either simple or complex tasks of document digitizing, archiving, and sharing. It is unlike any scanner in its price range.

1.2 Product Dimensions

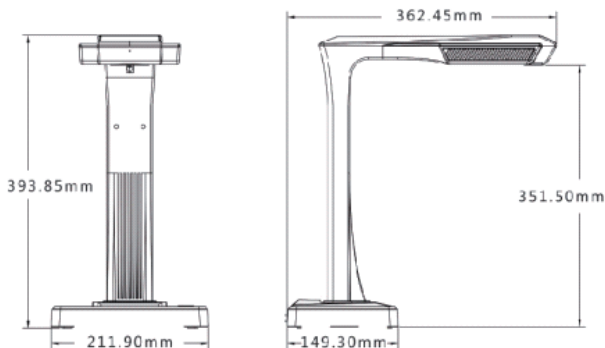

1.3 Product Appearance



LCD



CZUR Scanner

Connection Ports



Top Casing



Foot Pedal



Side Lights Port



Side Lights Touch Button

1. Microphone
2. Base
3. Top casing
4. Laser light
5. Vertical bar
6. LED brightness(high/low)
7. Scan(start next scan)
8. LCD (see LCD Notes below)
9. Video record indicator light
Blinking green lights= Recording in progress.
Green light off = Video record has been stopped.
10. Scan indicator light
11. Power indicator light (White)
12. HD CMOS camera
13. Bank of LED lights
14. Bank of LED lights
15. Power on/off switch
16. DC 9V \approx 1.5A, AC volt 100-240V 50/60Hz
17. To USB cable for computer connection
18. USB port for Foot Pedal or Hand Button
19. Hand button light "Scan in progress"
20. Hand button (to start next scan)
21. Foot pedal. The new foot pedal has the same function as the old foot pedal, and the specific one is subject to the actual receipt.
22. Side lights port
23. Side lights touch button
24. Zoom in and zoom out buttons (for HDMI mode only)
25. HDMI port (optional; some models have no HDMI function)

LCD Notes

LCD= Liquid Crystal Display, a type of flat-panel display screen.

When connected to a PC, displays if uploading or not to the PC.

1.4 Product Specifications

Type	Model	ET Series
Basic characteristics	Pixel	16M-40M
	Resolution	4608*3456-7296*5472
	Scanning speed	≈1.5S
	Format	≤A3
	Video format	MJPEG
	Picture format	JPG
	Export format	PDF/TIFF/WORD/EXCEL/Searchable PDF/PNG/BMP
Configuration parameters	Processor	32 MIPS CPU/Dual core openisc 32bit
	DDR	1Gbit
	Laser rays	3 laser rays
	LCD	√
	MIC	√
Specific functions	Smart scan	√
	OCR	√
	SDK	√
	Software function	Flattening Curve, Finger removal, smart paging, Smart tilt corrections and auto-cropping, auto-scan.
	Operating systems supported	XP/Win7/Win8/Win10/Win11, 32bit/64bit; macOS 10.13 and above

1.5 Packaging and Accessories

Item	Specification	Amount (pcs)
Scanner	CZUR smart scanner	1
Side lights	Magnetic connector	1
Hand button	USB interface, 1.2M	1
Foot pedal	USB interface, 2.0M	1
USB cable	USB interface, 1.5M	1
AC/DC power adapter	Input: AC 100-240V-50/60HZ, output: DC 9V=1.5A	1
Black document pad	530*401*2.0MM	1
Specialized finger cots	Left hand; Right hand	2
CD-ROM	CD-R, D=120MM	1
Getting Started Guide	Color printing, 100*83MM	1

Chapter II Operation Guidelines

2.1 Scanning Preparation

1. Place the scanner on a surface (table, desk, or counter) large enough to fit the pages you plan to scan or display.
2. Plug either the Hand Button or Foot Pedal into the scanner's USB port (in the back of the base).
3. Spread the black document pad under the scanner's head. Ensure that the gap of the "black document pad" aligned with device.

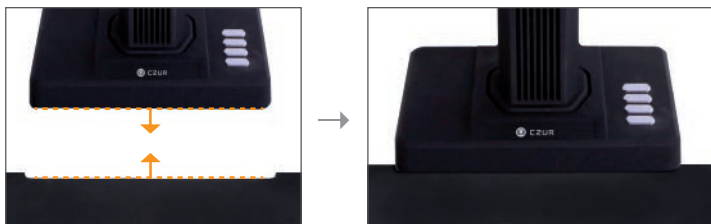

4. Check the LCD on the head portion to see if the black document pad covers the entire screen and ensure that the desk surface or random edges are not included within the scan. (it is extremely important to make sure that the black document pad covers the entire screen properly to help the smart algorithm carries out its calculations and ensure image processing is carried out properly).
5. Special reminders
 - 1) When scanning larger projects (such as books or multiple documents), we recommend using the Computer Mode (USB-PC) and connecting to the foot pedal to make the scanning process more efficient. Using a computer during scanning will provide additional editing functions to improve the quality and professionalism of the scanned and processed images.
 - 2) Avoid scanning documents in places near windows or environments with strong lighting. Excessively bright ambient lighting will affect the brightness of the ET laser lines and negatively affect scanning results.

- 3) When scanning books, the 3 laser lines of the ET scanner must be on the curved pages. Failure to do so will negatively affect scanning results.
- 4) Please wear the specialized finger cots provided with the ET scanner when holding down the pages during the scanning process to ensure that the finger removal function works properly. Failure to wear the finger cots would affect the finger removal algorithm.
- 5) When scanning, review your own needs and select the proper processing modes of either [Flat Single Page] or [Facing Pages].

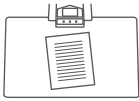

[Flat Single Page] mode for single, sheets of paper

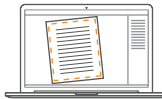

Auto-recognition of paper edges



Auto-cropping and tilt correction

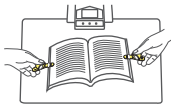

[Facing Pages] mode for bound sheets of paper (books)



Auto-recognition of page curvature



Auto-flattening of curved pages and removal of fingers (with finger cots)

- 6) When scanning magazines, coated paper, and other reflective materials, switch the side lights ON and switch the main lights OFF for best effects (only for advanced version).
- 7) Turn on the device's fill light to avoid shadow of the crossbar casing.
- 8) Turn off the top light and turn on the side fill light (for high-end version only) to avoid reflections when scanning ID documents, magazines, glossy paper, or glossy books.

2.2 Work Mode

2.2.1 Computer Mode (USB-PC)

- to control the scanner from a PC and store the scanings on its disk.
- Install the CZUR software on the PC. Get the CZUR software either from the enclosed CD, or from the website: <http://www.czur.com> →Support → ET Series.(macOS only supports downloading from website)
- Attach the USB cable from the scanner base to the PC. Turn everything on.



2.2.2 Presenter mode (HDMI;optional)

1. Connect the device to power supply with the adapter, and connect it to a display device such as a projector, TV, or electronic whiteboard with an HDMI cable (do not connect the device to a PC with a USB cable).

2. Turn on the "Power" button of the device and it will automatically enter the Presenter mode.

If there is no signal in the projector/TV, change the "signal source" of the projector/TV to "HDMI".

3. Function overview

The"  " and"  " buttons on the base can zoom in/out the display image up to 12 times at 6 levels.

If the paper position or text direction is incorrect, you can adjust it by moving the paper.

Chapter III Frequently Asked Questions and Troubleshooting

3.1 PC Mode (USB) Problems

- Unable to turn the scanner on. The LCD screen and power indicator light are dark.
 - Possible faulty power connection. Make sure the power supply actually has power, the adapter is properly connected, and the power switch is turned to On.
 - Sticky on/off switch. Turn the on/off switch on and off a few times.

- The software cannot be installed.
 - The software will only work on a Windows XP, 7, 8, 10 or 11 System and some macOS system. Or you may have entered the wrong scanner SN. Check the scanner SN underneath the base. Note that there is no number 1 (one) in the SN.
 - Anti-virus software may be interfering. Lower your anti-virus or firewall' s security level or disengage it while installing the CZUR software. Then reengage it.
 - Faulty software download. Download the software again & make sure it completely downloads before trying to install it.

- SN errors.
 - The scanner' s SN is underneath the base. Note that there is no number 1 (one) in the SN.

- When first using the software, nothing shows in the preview frame, and I am unable to scan.

- Make sure all USB connections are firm, especially between the scanner and the PC.
 - Make sure the PC' s "Device Manager" recognize the scanner. If you see a yellow exclamation mark with an "Unknown Device" indication, right click it to update the drive or disable and then re-enable device, and then retry the software.
 - Enter "device manager" , then disable the other "scanner" "camera" driver.
 - Try restarting the PC or using a different one.
- Scanned images are distorted, the font is twisted, or there are other distortions.
- The black document pad may be misaligned. Make sure it' s positioned properly under the scanner head. You cannot scan what won' t fit within the boundaries of this pad.
 - What you want to scan may be too big. It must fit within the boundaries of the matte black pad.
 - There might be interfering items in the preview area. Make sure none of the following are there: your hand, the Hand Button' s cord, your mobile phone, a pen, etc. Only the document to be scanned should be in the scanning preview area to allow the algorithms to work properly.

3.2 Presenter mode (HDMI; optional)

1. The device is powered on and is connected to a display device (projector or TV) via an HDMI cable, but no image is displayed and the device cannot enter the Presenter mode.
 - 1) Check whether the USB cable is disconnected from the computer. When both a USB cable and HDMI cable are connected to the device at the same time, the computer mode (USB-PC) is activated by default.
 - 2) Check whether the signal source of the projector or TV is "HDMI" input.
 - 3) Replace the HDMI cable or other display device.
 - 4) The "Zoom in" and "Zoom out" buttons are only valid in the Presenter mode (HDMI).

2. The direction of the content displayed by the projector is incorrect or the content is incomplete after being zoomed in.

The video presenter mode has no rotation and movement functions. You can adjust the content by rotating or moving the physical object.

Chapter IV Terms of Service

Dear user, thank you for using the smart scanner manufactured by our company. To protect your legal rights, please peruse and comply with the following standards and reminders.

4.1 After Sale Service and Guarantee

- All after sales policy of this product shall be subject to the laws and regulations of the country of sales.
- The scope of warranty covers the scanner device, the adapter, the hand button, and the foot pedal. Consumables and external appearances are not covered by the warranty.
- When sending in the product for repairs, please contact us or our local agent.
- We apologize for not issuing notices for subsequent upgrades or version updates of the product. This Company reserves the right of final decision on the interpretation of the above articles.

Warranty scope exception:

- This product may only be used in areas where surrounding temperature is less than 40 °C.
- Failures or damages caused by incorrect installation or using the product in environments that exceed the specified work conditions (for examples, in places that are too hot or too humid).
- Damages caused by using components not from this Company or when the user attempts to replace components by himself / herself.
- Damages caused by natural disasters, accidents, or human factors.
- Damages caused by inappropriate storage (including damages caused by rats or liquid infiltration) .
- Failures or damages caused by unauthorized repairs, modifications, or abuse carried out by the user.
- Damages caused by repairs carried out by unauthorized repair centers.
- Other errors and failures caused by software installation or software settings, or problems and failures caused by computer viruses.

4.2 Contact Information

Get technical support and information by following ways.

CZUR TECH CO., LTD.

9F, North Wing, West Block, PKU-HKUST ShenZhen-HongKong Institution, Gaoxin South 7th Road, Nanshan District, Shenzhen, China

Room1001,10th Floor, Block A, No.32A Huoju Road, High-tech Industrial Zone, Dalian City, Liaoning Province, China

E-Mail: support@czur.com Skype: [support@czur.com](https://www.skype.com/people/support@czur.com)
www.czur.com

CZUR TECH CO., LTD.

9F, North Wing, West Block, PKU-HKUST ShenZhen-HongKong Institution,
Gaoxin South 7th Road, Nanshan District, Shenzhen, China

Room1001,10th Floor, Block A, No.32A Huoju Road, High-tech Industrial
Zone, Dalian City, Liaoning Province, China

Courriel: support@czur.com Assistance sur Skype: [support@czur.com](https://www.skype.com/contact)
www.czur.com